

5-year warranty

Type overview

Type	Stroke
UGLK1404	3/4" (17 teeth)

Technical data

Functional data	Fluid Temp Range (water)	Please Refer to Manufacturer's Valve Specifications
	Mounting Position	360°
	Applicable valve size	1.5...3" [40...80]
Materials	Hardware	stainless steel
	Spindle	brass
	Stem adapter	brass
	Bearing	bronze
	Frame, plate, base	stainless steel
	Collar	brass
	Rack	sintered steel
Suitable actuators	Non-Spring	AMB(X) GMB(X)
	Spring	AF NF

For close-off pressure reference Select Pro or retrofit technical documentation.

Product features

- Default/Configuration** The actuator is sold separately from the linkage. This allows users to select any actuator with the desired control signal. Since the linkage utilizes standard airside actuators, they can be purchased at any time and mounted in the field. Due to the free-spring design of the linkage, clearance is not an issue. The linkage can be oriented at any angle on the valve cap.
- Application** The UGLK retrofit kit is designed to easily attach to the valve bonnet on select competitor valves utilizing Belimo actuators. The kit is used to restore service to the valve without removal of the valve, saving down time. The unique collar design allows the UGLK to be mounted on various two-way or three-way valves. In addition, the rack and pinion construction allow the linkage to be used with normally open and normally closed valves.
- Operation** The UGLK linkage provides downward travel with 95° rotation on the actuator. The linkage travel is based on the size of gear inside. The size of the gear is stamped on the frame. This allows the valve to extend fully open or closed based on signal. When directional needs vary, the actuator can be flipped or directional switch turned to a new rotation. The compact design allows for installation in tight spaces.

Dimensions

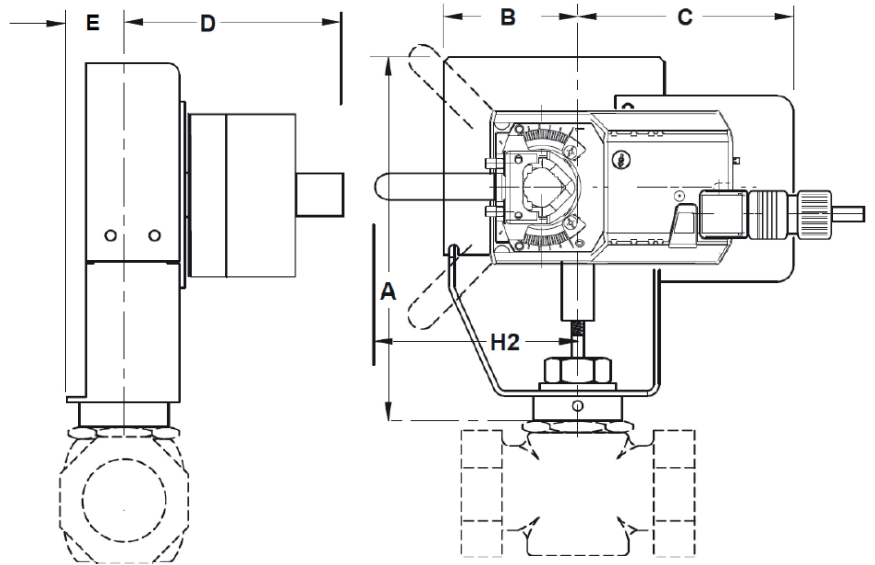

AMB, AMX, GKB, GKX, GMB, GMX

A	B	C	D	E	H2
9.4" [239]	2.5" [63]	7.5" [191]	4.8" [122]	1.4" [35]	3.5" [89]

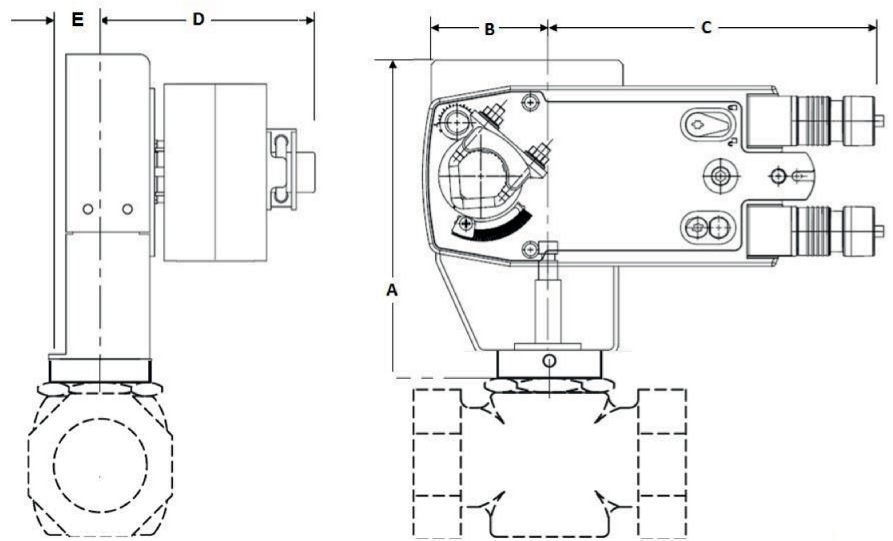

AFB, AFX, NFB, NFX

A	B	C	D	E
9.4" [239]	2.5" [63]	7.5" [191]	4.8" [122]	1.4" [35]