



5-year warranty

Technical data

Functional data	Mounting Position	90° to 180°
	Safety data	Ambient temperature
	Storage temperature	-40...176°F [-40...80°C]
Materials	Housing material	galvanized steel
	Stem	steel
	Frame, plate, base	galvanized steel
	Bearing	GF Delrin
Suitable actuators	Non-Spring	AMB(X) GMB(X) NMB(X)
	Electronic fail-safe	NKQB(X)

* ZG-121 adapter must be used with EF. ** GM/GK not for use with 1/2" shafts. *** K6-1 clamp must be used with LF. For close-off pressure reference Select Pro or Retrofit Technical Documentation.
For close-off pressure reference Select Pro or retrofit technical documentation.

Product features

- Default/Configuration** The ZG-JSL linkage can also be configured by moving the anti-rotation plate 90° for space-saving applications. See mounting configurations below. The ZG-JSLA will have a factory mounted actuator on the linkage in the vertical position only.
- Application** The ZG-JSL jackshaft linkage is designed to easily attach to any part of a jackshaft and allow easy installation of select Belimo actuators. The unique open ended design and clamp insert allows the ZG-JSL to be used with any jackshaft from 1/2" to 3/4" in diameter. Removal of the insert will allow the linkage to attach to a maximum shaft diameter of 1.05". Changing the antirotation plate will allow various actuators to be mounted.
- Operation** The 3/4" diameter built-in steel shaft allows direct coupling to the Belimo series actuators in the chart below. There is a torque reduction when using the ZG-JSL linkage. Verify application requirements before use.

Flow/Mounting details



Dimensions

Dimensional drawings

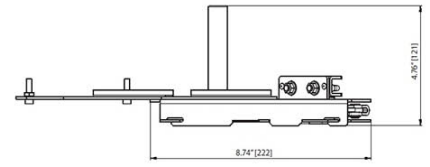
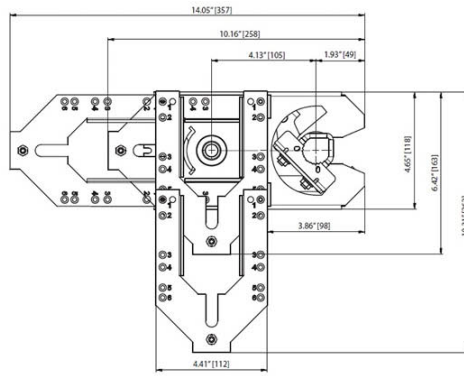



5-year warranty



MFT

Technical data

Electrical data	Nominal voltage	AC/DC 24 V
	Nominal voltage frequency	50/60 Hz
	Power consumption in operation	6.5 W
	Power consumption in rest position	3 W
	Transformer sizing	9 VA (class 2 power source)
	Auxiliary switch	2 x SPDT, 3 A resistive (0.5 A inductive) @ AC 250 V, one set at 10°, one adjustable 10...90°
	Switching capacity auxiliary switch	3 A resistive (0.5 A inductive) @ AC 250 V
	Electrical Connection	(2) 18 GA appliance cables with or without 1/2" conduit connectors, 3 ft [1 m], 10 ft [3 m] or 16ft [5 m]
	Overload Protection	electronic throughout 0...95° rotation
	Electrical Protection	actuators are double insulated
Functional data	Torque motor	90 in-lb [10 Nm]
	Operating range Y	2...10 V
	Operating range Y note	4...20 mA w/ ZG-R01 (500 Ω, 1/4 W resistor)
	Input Impedance	100 kΩ for 2...10 V (0.1 mA), 500 Ω for 4...20 mA, 1500 Ω for PWM, On/Off and Floating point
	Operating range Y variable	Start point 0.5...30 V End point 2.5...32 V
	Options positioning signal	variable (VDC, PWM, on/off, floating point)
	Position feedback U	2...10 V
	Position feedback U note	Max. 0.5 mA
	Position feedback U variable	VDC variable
	Direction of motion motor	selectable with switch 0/1
	Direction of motion fail-safe	reversible with cw/ccw mounting
	Manual override	5 mm hex crank (3/16" Allen), supplied
	Angle of rotation	95°, adjustable with mechanical end stop, 35...95°
	Angle of rotation note	adjustable with mechanical end stop, 35...95°
	Running Time (Motor)	default 150 s, variable 40...150 s
	Running time motor variable	40...150 s
	Running time fail-safe	<20 s @ -4...122°F [-20...50°C], <60 s @ -22°F [-30°C]
	Angle of rotation adaptation	off (default)
	Override control	MIN (minimum position) = 0% MID (intermediate position) = 50% MAX (maximum position) = 100%
	Noise level, motor	40 dB(A)
	Noise level, fail-safe	62 dB(A)
	Shaft Diameter	1/2...1.05" round, centers on 1/2" and 3/4" with insert, 1.05" without insert

	Position indication	Mechanical
Safety data	Degree of protection IEC/EN	IP54
	Degree of protection NEMA/UL	NEMA 2 UL Enclosure Type 2
	Agency Listing	cULus acc. to UL60730-1A/-2-14, CAN/CSA E60730-1:02, CE acc. to 2014/30/EU and 2014/35/EU
	Quality Standard	ISO 9001
	Ambient temperature	-22...122°F [-30...50°C]
	Storage temperature	-40...176°F [-40...80°C]
	Ambient humidity	max. 95% r.H., non-condensing
	Servicing	maintenance-free
Weight	Weight	3.8 lb [1.7 kg]
	Materials	Housing material

Product features

Default/Configuration	Default parameters for 2 to 10 VDC applications of the NF..-MFT actuator are assigned during manufacturing. If required, custom versions of the actuator can be ordered. The parameters are variable and can be changed by three means: Factory pre-set or custom configuration, set by the customer using PC-Tool software or the handheld ZTH US.
Application	For fail-safe, modulating control of dampers in HVAC systems. Actuator sizing should be done in accordance with the damper manufacturer's specifications. A feedback signal is provided for position indication.
Operation	The NF..24-MFT actuator provides 95° of rotation and is provided with a graduated position indicator showing 0° to 95°. The actuator will synchronize the 0° mechanical stop or the physical damper or valve mechanical stop and use this point for its zero position during normal control operations. A unique manual override allows the setting of any actuator position within its 95° of rotation with no power applied. This mechanism can be released physically by the use of a crank supplied with the actuator. When power is applied the manual override is released and the actuator drives toward the fail-safe position. The actuator uses a brushless DC motor which is controlled by an Application Specific Integrated Circuit (ASIC) and a microprocessor. The microprocessor provides the intelligence to the ASIC to provide a constant rotation rate and to know the actuators's exact position. The ASIC monitors and controls the brushless DC motor's rotation and provides a Digital Rotation Sensing (DRS) function to prevent damage to the actuator in a stall condition. The position feedback signal is generated without the need for mechanical feedback potentiometers using DRS. The actuator may be stalled anywhere in its normal rotation without the need of mechanical end switches. The NF..24-MFT is mounted directly to control shafts up to 1.05" diameter by means of its universal clamp and anti-rotation bracket. A crank arm and several mounting brackets are available for damper applications where the actuator cannot be direct coupled to the damper shaft. The spring return system provides minimum specified torque to the application during a power interruption. The NF..24-MFT actuator is shipped at 5° (5° from full fail-safe) to provide automatic compression against damper gaskets for tight shut-off.
Typical specification	Spring return control damper actuators shall be direct coupled type which require no crank arm and linkage and be capable of direct mounting to a jackshaft up to a 1.05" diameter. The actuator must provide modulating damper control in response to a 2 to 10 VDC or, with the addition of a 500Ω resistor, a 4 to 20 mA control input from an electronic controller or positioner. The actuators must be designed so that they may be used for either clockwise or counter clockwise fail-safe operation. Actuators shall use a brushless DC motor controlled by a microprocessor and be protected from overload at all angles of rotation. Run time shall be constant, and independent of torque. A 2 to 10 VDC feedback signal shall be provided for position feedback. Actuators shall be cULus listed and have a 5 year warranty, and be manufactured under ISO 9001 International Quality Control Standards. Actuators shall be as manufactured by Belimo.
Factory settings	Default parameters for 2 to 10 VDC applications of the NF..-MFT actuator are assigned during manufacturing. If required, custom versions of the actuator can be ordered. The parameters are variable and can be changed by three means: Factory pre-set or custom configuration, set by the customer using PC-Tool software or the handheld ZTH US.

Accessories

Gateways	Description	Type
	Gateway MP to BACnet MS/TP	UK24BAC
	Gateway MP to LonWorks	UK24LON
	Gateway MP to Modbus RTU	UK24MOD
Electrical accessories	Description	Type
	DC Voltage Input Rescaling Module	IRM-100
	Belimo PC-Tool, Software for adjustments and diagnostics	MFT-P
	Auxiliary switch, mercury-free	P475
	Auxiliary switch, mercury-free	P475-1
	Signal Simulator, Power supply AC 230 V	PS-100
	Convert Pulse Width Modulated Signal to a 2...10 V Signal for Belimo Proportional Actuators	PTA-250
	Positioner for wall mounting	SGA24
	Positioner for front-panel mounting	SGF24
	Cable Conduit Connector 1/2"	TF-CC US
	Gateway MP to BACnet MS/TP	UK24BAC
	Gateway MP to LonWorks	UK24LON
	Gateway MP to Modbus RTU	UK24MOD
	Resistor, 500 Ω, 1/4" wire resistor with 6" pigtail wires	ZG-R01
	Resistor Kit, 50% voltage divider	ZG-R02
	Mounting plate for SGF.	ZG-SGF
	Transformer, AC 120 V to AC 24 V, 40 VA	ZG-X40
	Connection cable 16 ft [5 m], A: RJ11 6/4 ZTH EU, B: free wire end for connection to MP/PP terminal	ZK2-GEN
	Service Tool, with ZIP-USB function, for parametrisable and communicative Belimo actuators, VAV controller and HVAC performance devices	ZTH US
Mechanical accessories	Description	Type
	Anti-rotation bracket, for AF / NF	AF-P
	Shaft extension 240 mm Ø20 mm for damper shaft Ø 8...22.7 mm	AV8-25
	End stop indicator	IND-AFB
	Shaft clamp reversible, for central mounting, for damper shafts Ø12.7 / 19.0 / 25.4 mm	K7-2
	Ball joint suitable for damper crank arm KH8 / KH10	KG10A
	Ball joint suitable for damper crank arm KH8	KG8
	Actuator arm, for 3/4" shafts, clamping range Ø10...22 mm, Slot width 8.2 mm	KH-AFB
	Damper crank arm Slot width 8.2 mm, clamping range Ø14...25 mm	KH10
	Damper crank arm Slot width 8.2 mm, for Ø1.05"	KH12
	Damper crank arm Slot width 8.2 mm, clamping range Ø10...18 mm	KH8
	Push rod for KG10A ball joint (36" L, 3/8" diameter).	SH10
	Push rod for KG6 & KG8 ball joints (36" L, 5/16" diameter).	SH8
	Wrench 8 mm and 10 mm	TOOL-06
	Retrofit clip	Z-AF
	Base plate extension	Z-SF
	17" Mounting Bracket for AF,NF,GM,AM,SM	ZG-100
	Mounting Bracket: AF,NF,LF,GM,AM,NM,SM	ZG-101
	Mounting Bracket: ZS-260 Right Angle	ZG-109
	Linkage kit	ZG-110
	Mounting bracket for AF / NF	ZG-118
	Jackshaft mounting bracket.	ZG-120
	Mounting kit for linkage operation for flat and side installation	ZG-AFB
	Mounting kit for foot mount installation	ZG-AFB118
	Damper clip for damper blade, 3.5" width.	ZG-DC1
	Damper clip for damper blade, 6" width.	ZG-DC2
	1" diameter jackshaft adaptor (11" L).	ZG-JSA-1
	1-5/16" diameter jackshaft adaptor (12" L).	ZG-JSA-2
	1.05" diameter jackshaft adaptor (12" L).	ZG-JSA-3
	Weather shield 13x8x6" [330x203x152 mm] (LxWxH)	ZS-100
	Base Plate, for ZS-100	ZS-101
	Weather shield 16x8-3/8x4" [406x213x102 mm] (LxWxH)	ZS-150

Explosion Proof Housing 16x10x6.435" [406x254x164 mm] (LxWxH), UL and CSA, Class I, Zone 1&2, Groups B, C, D, (NEMA 7), Class III, Hazardous (classified)	ZS-260
Locations	
Weather shield 17-1/4x8-3/4x5-1/2" [438x222x140 mm] (LxWxH), NEMA 4X, with mounting brackets	ZS-300
Weather shield 17-1/4x8-3/4x5-1/2" [438x222x140 mm] (LxWxH), NEMA 4X, with mounting brackets	ZS-300-5
Shaft extension 1/2"	ZS-300-C1
Shaft extension 3/4"	ZS-300-C2
Shaft extension 1"	ZS-300-C3

Service tools	Description	Type
	Connection cable 10 ft [3 m], A: RJ11 6/4 ZTH EU, B: 3-pin Weidmüller and supply connection	ZK4-GEN
	Service Tool, with ZIP-USB function, for parametrisable and communicative Belimo actuators, VAV controller and HVAC performance devices	ZTH US

Electrical installation
⚠ Warning! Live Electrical Components!

During installation, testing, servicing and troubleshooting of this product, it may be necessary to work with live electrical components. Have a qualified licensed electrician or other individual who has been properly trained in handling live electrical components perform these tasks. Failure to follow all electrical safety precautions when exposed to live electrical components could result in death or serious injury.

- ◆ Meets cULus requirements without the need of an electrical ground connection.
- ⚡ Apply only AC line voltage or only UL-Class 2 voltage to the terminals of auxiliary switches. Mixed or combined operation of line voltage/safety extra low voltage is not allowed.
- Ⓐ Actuators with appliance cables are numbered.
- 1 Provide overload protection and disconnect as required.
- 3 Actuators may also be powered by 24 VDC.
- 4 Two built-in auxiliary switches (2x SPDT), for end position indication, interlock control, fan startup, etc.
- 5 Only connect common to negative (-) leg of control circuits.
- 7 A 500 Ω resistor (ZG-R01) converts the 4...20 mA control signal to 2...10 V.
- 8 Control signal may be pulsed from either the Hot (Source) or Common (Sink) 24 V line.
- 10 For triac sink the Common connection from the actuator must be connected to the Hot connection of the controller. Position feedback cannot be used with a triac sink controller; the actuator internal common reference is not compatible.
- 11 Actuators may be connected in parallel if not mechanically linked. Power consumption and input impedance must be observed.
- 12 IN4004 or IN4007 diode. (IN4007 supplied, Belimo part number 40155).

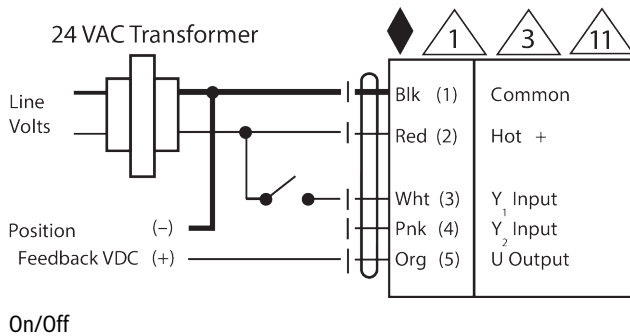

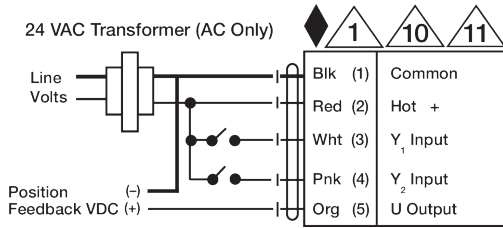

Floating Point

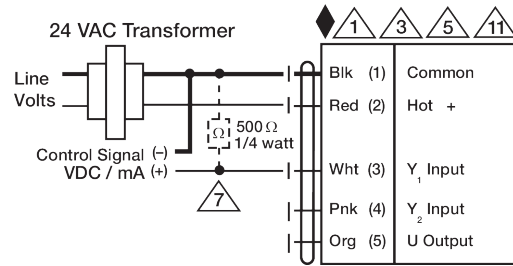

VDC/ mA Control

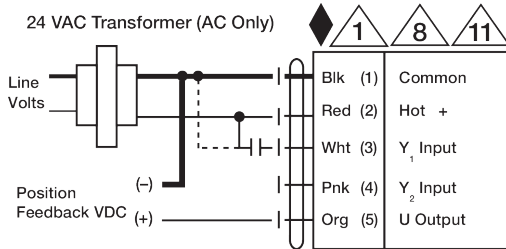

PWM Control

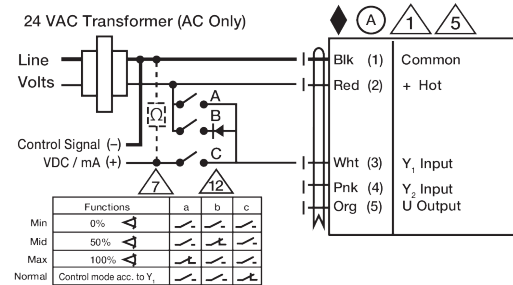

Override Control

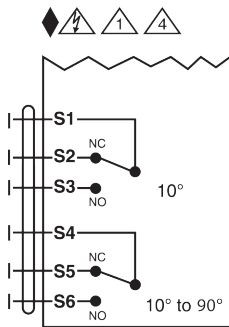

Auxiliary Switches

Dimensions

Dimensional drawings

