



5-year warranty

**Technical data**

<b>Functional data</b>	Valve Size	2.5" [65]
	Fluid	chilled or hot water, up to 60% glycol
	Fluid Temp Range (water)	32...350°F [0...176°C]
	Body Pressure Rating	ANSI Class 250, up to 280 psi below 350°F
	Body pressure rating note	up to 280 psi below 350°F
	Flow characteristic	linear
	Servicing	repack/rebuild kits available
	Rangeability Sv	50:1
	Flow Pattern	3-way Mixing
	Leakage rate	ANSI Class III
	Controllable flow range	stem up - open B – AB
	Cv	68
<b>Materials</b>	Valve body	Cast iron - ASTM A126 Class B
	Valve plug	Stainless steel
	Stem	316 stainless steel
	Stem seal	NLP EPDM (no lip packing)
	Seat	Stainless steel AISI 316
	Pipe connection	250 lb flanged
<b>Suitable actuators</b>	Non-Spring	EVB(X) RVB(X)
	Spring	AF (2*AFB(X))
	Electronic fail-safe	AVKB(X) (2*GKB(X))

**Safety notes**

- **WARNING:** This product can expose you to lead which is known to the State of California to cause cancer and reproductive harm. For more information go to [www.p65warnings.ca.gov](http://www.p65warnings.ca.gov)
- The valve has been designed for use in stationary heating, ventilation and air-conditioning systems and must not be used outside the specified field of application, especially in aircraft or in any other airborne means of transport.
- Only authorized specialists may carry out installation. All applicable legal or institutional installation regulations must be complied during installation.
- The valve does not contain any parts that can be replaced or repaired by the user.
- When determining the flow rate characteristic of controlled devices, the recognised directives must be observed.

Product features

Flow/Mounting details

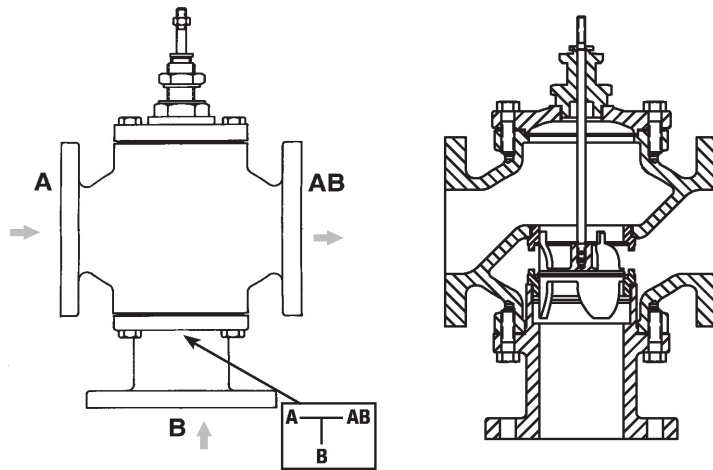

Dimensions

Dimensional drawings

EVB, EVX, RVB, RVX

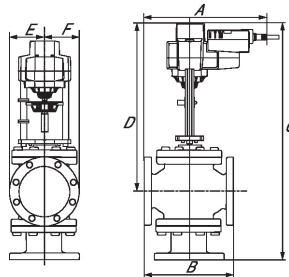

A	B	C	D	E	F	Number of Bolt Holes
12.0" [304]	9.6" [245]	25.4" [646]	18.3" [464]	3.7" [95]	3.7" [95]	8

2\*GMB, 2\*GMX, 2\*GKB, 2\*GKX

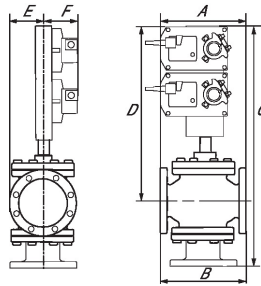

A	B	C	D	E	F	Number of Bolt Holes
12.0" [304]	9.6" [245]	29.0" [736]	21.8" [554]	3.7" [95]	5.3" [135]	8

AVKB, AVKX

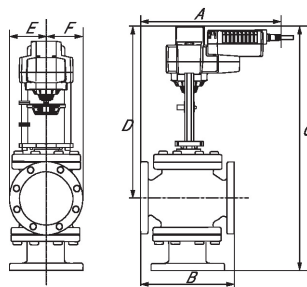

A	B	C	D	E	F	Number of Bolt Holes
12.0" [304]	9.6" [245]	25.4" [646]	18.3" [464]	3.7" [95]	3.7" [95]	8

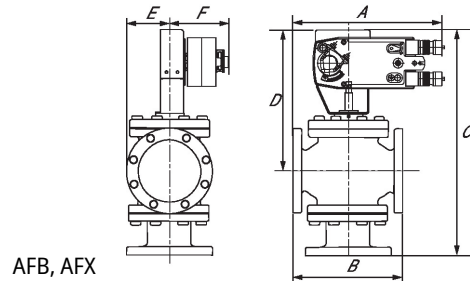

A	B	C	D	E	F	Number of Bolt Holes
12.0" [304]	9.6" [245]	24.0" [610]	16.9" [428]	3.7" [95]	5.3" [135]	8

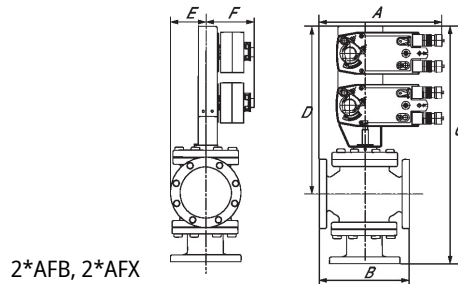

A	B	C	D	E	F	Number of Bolt Holes
12.0" [304]	9.6" [245]	29.0" [736]	21.8" [554]	3.7" [95]	5.3" [135]	8



5-year warranty



Technical data

<b>Electrical data</b>	Nominal voltage	AC/DC 24 V
	Nominal voltage frequency	50/60 Hz
	Power consumption in operation	12 W
	Power consumption in rest position	3 W
	Transformer sizing	40 VA (class 2 power source)
	Electrical Connection	18 GA plenum cable with 1/2" conduit connector, degree of protection NEMA 2 / IP54, 3 ft [1 m] 10 ft [3 m] and 16ft [5 m]
	Overload Protection	electronic throughout 0...95° rotation
<b>Functional data</b>	Options positioning signal	variable (VDC, on/off, floating point)
	Position feedback U variable	VDC variable
	Bridging time	programmable 0...10 s (2 s default) delay before fail-safe activates
	Pre-charging time	5...20 s
	Direction of motion motor	selectable with switch 0/1
	Direction of motion fail-safe	reversible with switch
	Manual override	external push button
	Angle of rotation	Max. 95°, max. 95°, adjustable with mechanical stop
	Angle of rotation note	max. 95°, adjustable with mechanical stop
	Running Time (Motor)	default 150 s, variable 95...150 s
	Running time motor variable	95...150 s
	Running time fail-safe	<35 s
	Noise level, motor	52 dB(A)
	Noise level, fail-safe	61 dB(A)
Position indication	Mechanically, 30...65 mm stroke	
<b>Safety data</b>	Degree of protection IEC/EN	IP54
	Degree of protection NEMA/UL	NEMA 2
	Enclosure	UL Enclosure Type 2
	Agency Listing	cULus acc. to UL60730-1A/-2-14, CAN/CSA E60730-1:02, CE acc. to 2014/30/EU and 2014/35/EU; Listed to UL 2043 - suitable for use in air plenums per Section 300.22(c) of the NEC and Section 602.2 of the IMC
	Quality Standard	ISO 9001
	Ambient temperature	-22...122°F [-30...50°C]
	Storage temperature	-40...176°F [-40...80°C]
	Ambient humidity	Max. 95% RH, non-condensing
	Servicing	maintenance-free
	<b>Weight</b>	Weight

**Product features**
**Mode of operation** SY9~12 Replacement Handwheel

**Accessories**

Gateways	Description	Type
	Gateway MP to BACnet MS/TP	UK24BAC
	Gateway MP to LonWorks	UK24LON
	Gateway MP to Modbus RTU	UK24MOD
Electrical accessories	Description	Type
	Feedback potentiometer 10 kΩ add-on, grey	P10000A GR
	Feedback potentiometer 1 kΩ add-on, grey	P1000A GR
	Feedback potentiometer 140 Ω add-on, grey	P140A GR
	Feedback potentiometer 2.8 kΩ add-on, grey	P2800A GR
	Feedback potentiometer 5 kΩ add-on, grey	P5000A GR
	Feedback potentiometer 500 Ω add-on, grey	P500A GR
	Auxiliary switch 1 x SPDT add-on	S1A
	Auxiliary switch 2 x SPDT add-on	S2A
	Service Tool, with ZIP-USB function, for programmable and communicative Belimo actuators, VAV controller and HVAC performance devices	ZTH US
Service tools	Description	Type
	Connection cable 10 ft [3 m], A: RJ11 6/4 ZTH EU, B: 3-pin Weidmüller and supply connection	ZK4-GEN
	Service Tool, with ZIP-USB function, for programmable and communicative Belimo actuators, VAV controller and HVAC performance devices	ZTH US

**Electrical installation**
**INSTALLATION NOTES**

- Actuators with appliance cables are numbered.
- Provide overload protection and disconnect as required.
- Actuators may also be powered by DC 24 V.
- Only connect common to negative (-) leg of control circuits.
- A 500 Ω resistor (ZG-R01) converts the 4...20 mA control signal to 2...10 V.
- Control signal may be pulsed from either the Hot (Source) or Common (Sink) 24 V line.
- For triac sink the Common connection from the actuator must be connected to the Hot connection of the controller. Position feedback cannot be used with a triac sink controller; the actuator internal common reference is not compatible.
- IN4004 or IN4007 diode. (IN4007 supplied, Belimo part number 40155).
- Actuators may be controlled in parallel. Current draw and input impedance must be observed.
- Master-Slave wiring required for piggy-back applications. Feedback from Master to control input(s) of Slave(s).
- Meets cULus requirements without the need of an electrical ground connection.
- Warning! Live electrical components!**  
During installation, testing, servicing and troubleshooting of this product, it may be necessary to work with live electrical components. Have a qualified licensed electrician or other individual who has been properly trained in handling live electrical components perform these tasks. Failure to follow all electrical safety precautions when exposed to live electrical components could result in death or serious injury.

**Wiring diagrams**

On/Off

24 VAC Transformer



Floating Point

24 VAC Transformer (AC Only)

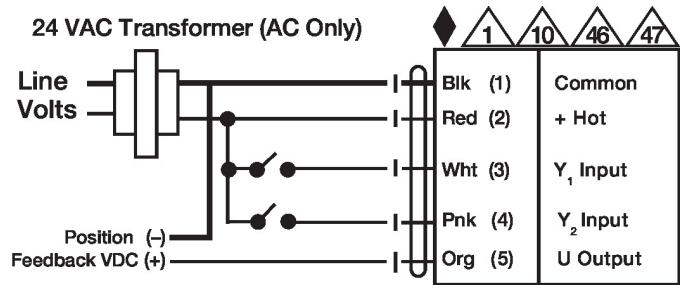

VDC/mA Control

24 VAC Transformer



PWM Control

24 VAC Transformer (AC only)

