

2-year warranty

Type overview

Type	DN
F7125-300SHP	125

Technical data

Functional data	Valve size [mm]	5" [125]
	Fluid	chilled or hot water, up to 60% glycol
	Fluid Temp Range (water)	-22...400°F [-30...204°C]
	Body Pressure Rating	ANSI Class 300
	Flow characteristic	modified linear, unidirectional
	Servicing	maintenance-free
	Flow Pattern	3-way Mixing/Diverting
	Leakage rate	0%
	Controllable flow range	quarter turn, mechanically limited
	Cv	714
	Maximum Velocity	32 FPS
	Lug threads	3/4-10 UNC
Materials	Valve body	Carbon steel full lug (ASME B16.34)
	Stem	17-4 PH stainless steel
	Seat	RPTFE
	Pipe connection	ASME/ANSI class 300 flange
	Bearing	glass backed PTFE
	Disc	316 stainless steel
Suitable actuators	Non-Spring	SY4

Safety notes



- WARNING: This product can expose you to lead which is known to the State of California to cause cancer and reproductive harm. For more information go to www.p65warnings.ca.gov

Product features

Flow/Mounting details



Dimensions

Type	DN	Weight
F7125-300SHP	125	165.4 lb [75 kg]

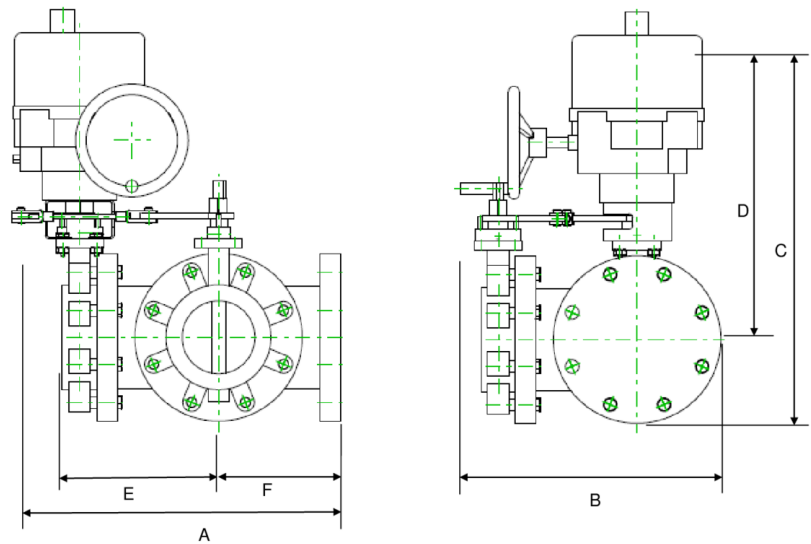

A	B	C	D	E	F	Number of Bolt Holes
21.5" [547]	15.8" [401]	27.0" [686]	21.5" [546]	10.4" [263]	8.0" [203]	8

On/Off, Floating point, Non fail-safe, 120 V



2-year warranty

Technical data

Electrical data	Nominal voltage	AC 120 V
	Nominal voltage frequency	50/60 Hz
	Nominal voltage range	AC 96...132 V
	Transformer sizing	253 VA
	Current consumption	2.1 A
	Auxiliary switch	2x SPDT, 1 mA...5 A (3 A inductive), DC 5 V...AC 250 V, 1 x 3° / 1 x 87°
	Switching capacity auxiliary switch	1 mA...5 A (3 A inductive), DC 5 V...AC 250 V
	Electrical Connection	Terminal blocks
	Overload Protection	thermally protected 135°C cut-out
	Internal Humidity Control	resistive heating element
Functional data	Torque motor	400 Nm
	Direction of motion motor	selectable with switch 0/1
	Manual override	hand wheel
	Angle of rotation	90°
	Running Time (Motor)	19 s
	Duty cycle value	30%
	Noise level, motor	45 dB(A)
	Position indication	top mounted domed indicator
Safety data	Degree of protection IEC/EN	IP66/67
	Degree of protection NEMA/UL	NEMA 4X
	Enclosure	UL Enclosure Type 4X
	Agency Listing	ISO, CE, cCSAus
	Quality Standard	ISO 9001
	Ambient humidity	Max. 100% RH
	Ambient temperature	-22...149°F [-30...65°C]
	Storage temperature	-40...176°F [-40...80°C]
Servicing	maintenance-free	
Weight	Weight	160 lb [72 kg]
Materials	Housing material	die cast aluminium
	Gear train	high alloy steel gear sets, self locking

Product features

Application SY Series actuators are fractional horsepower devices, and utilize full-wave power supplies. Observe wire sizing and transformer sizing requirements. Proportional models CANNOT be connected to Belimo direct coupled (AF, AM, GM...etc) actuator power supplies or any type of half-wave device. You MUST use a separate, dedicated transformer or power supply to power the SY actuator. Please do not connect other automation equipment to the dedicated SY supply source. You MUST use four wires (plus a ground) to control a proportional control SY actuator (See SY Wiring Section).

Accessories

Electrical accessories	Description	Type
	Local electric disconnect for SY4...12 series actuator, AC 120 V, on/off	HOA-120V
	Battery backup system for SY4...6 series actuator, AC 120 V, on/off	EXT-NSV-B03-120
	Battery backup system for SY4...6 series actuator, AC 120 V, MFT	EXT-NSV-B04-120
	Battery backup system for SY4...5 series actuator, AC 24 V, on/off	EXT-NSV-B13-24
	Battery backup system for SY4...5 series actuator, AC 24 V, MFT	EXT-NSV-B14-24

Electrical installation

INSTALLATION NOTES

- Do not change sensitivity or dip switch setting with power applied.
- Power supply Common/Neutral and Control Signal "-" wiring to a common is prohibited. Terminals 4 and 6 need to be wired separately.
- Isolation relays must be used in parallel connection of multiple actuators using a common control signal inputs. The relays should be DPDT.
- Isolation relays are required in parallel applications. The reason parallel applications need isolation relays is that the motor uses two sets of windings, one for each direction. When one is energized to turn the actuator in a specific direction a voltage is generated in the other due to the magnetic field created from the first. It's called back EMF. This is not an issue with one actuator because the voltage generated in the second winding isn't connected to anything so there is no flow. On parallel applications without isolation, this EMF voltage energizes the winding it is connected to on the other actuators in the system, the actuators are trying to turn in both directions at once. The EMF voltage is always less than the supply voltage due to the resistance of the windings, so while the actuator still turns in the commanded direction, the drag from the other reduces the torque output and causes overheating.
- Warning! Live electrical components!**
During installation, testing, servicing and troubleshooting of this product, it may be necessary to work with live electrical components. Have a qualified licensed electrician or other individual who has been properly trained in handling live electrical components perform these tasks. Failure to follow all electrical safety precautions when exposed to live electrical components could result in death or serious injury.

Electrical installation

Wiring diagrams

AC/DC 110/120 or 220/230V

AC 110/120 or 220/230 V

