

Butterfly Valve with ANSI Class 150 Lug types

- Disc 316 stainless steel
- Bubble tight shut-off
- Teflon seat
- Valve face-to-face dimensions comply with API 609 & MSS-SP-67
- For use with dead-end service
- Completely assembled and tested, ready for installation



5-year warranty

Type overview

Type	DN
F6250-150SHP	250

Technical data

Functional data	Valve size [mm]	10" [250]
	Fluid	chilled or hot water, up to 60% glycol, steam
	Fluid Temp Range (water)	-22...400°F [-30...204°C]
	Body Pressure Rating	ANSI Class 150
	Flow characteristic	modified equal percentage, unidirectional
	Pipe connection	Flange for use with ASME/ANSI class 150
	Servicing	maintenance-free
	Flow Pattern	2-way
	Leakage rate	0%
	Controllable flow range	quarter turn, mechanically limited
	Cv	3517
	Maximum Inlet Pressure (Steam)	50 psi
	Maximum Velocity	32 FPS
	Lug threads	7/8-9 UNC
Materials	Valve body	Carbon steel full lug (ASME B16.34)
	Stem	17-4 PH stainless steel
	Seat	RPTFE
	Bearing	glass backed PTFE
	Disc	316 stainless steel
Suitable actuators	Non Fail-Safe	SY4

Safety notes

- **WARNING:** This product can expose you to lead which is known to the State of California to cause cancer and reproductive harm. For more information go to www.p65warnings.ca.gov

Product features

Flow/Mounting details

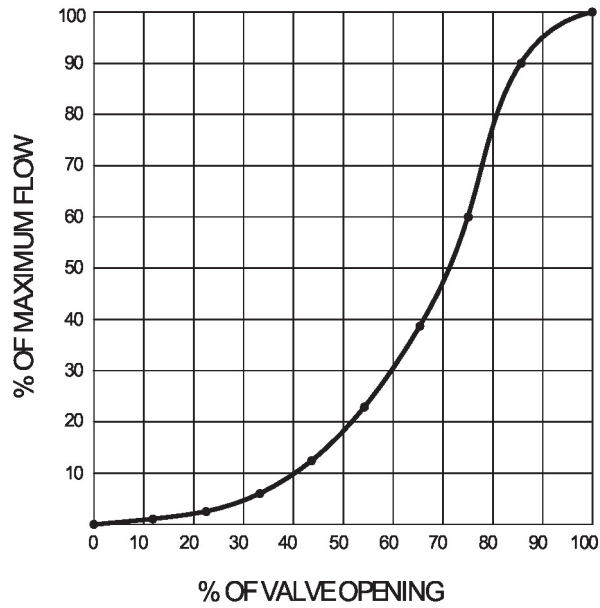

Dimensions

Type	DN	Weight
F6250-150SHP	250	33 lb [15 kg]

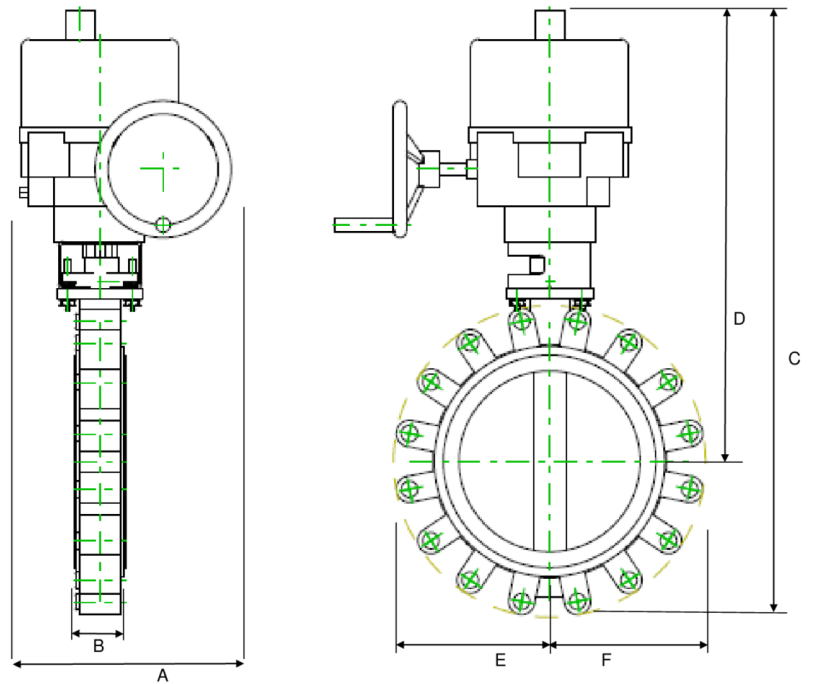

A	B	C	D	E	F	Number of Bolt Holes
11.5" [293]	2.8" [70]	31.9" [810]	25.1" [638]	8.0" [203]	8.0" [203]	12

MFT/programmable, Non fail-safe, 120 V



2-year warranty

Technical data

Electrical data	Nominal voltage	AC 120 V
	Nominal voltage frequency	50/60 Hz
	Nominal voltage range	AC 96...132 V
	Transformer sizing	253 VA
	Current consumption	2.1 A
	Auxiliary switch	2x SPDT, 1 mA...5 A (3 A inductive), DC 5 V...AC 250 V, 1 x 3° / 1 x 87°
	Switching capacity auxiliary switch	1 mA...5 A (3 A inductive), DC 5 V...AC 250 V
	Electrical Connection	Terminal blocks
	Overload Protection	thermally protected 135°C cut-out
	Internal Humidity Control	resistive heating element
Functional data	Torque motor	400 Nm
	Operating range Y	2...10 V
	Input impedance	100 kΩ
	Position feedback U	2...10 V
	Position feedback U note	Max. 0.5 mA
	Position feedback U variable	VDC variable
	Direction of motion motor	selectable with switch 0/1
	Manual override	hand wheel
	Angle of rotation	90°
	Running Time (Motor)	24 s
	Duty cycle value	75%
	Noise level, motor	45 dB(A)
	Position indication	top mounted domed indicator
Safety data	Degree of protection IEC/EN	IP66/67
	Degree of protection NEMA/UL	NEMA 4X
	Enclosure	UL Enclosure Type 4X
	Agency Listing	ISO, CE, cCSAus
	Quality Standard	ISO 9001
	Ambient humidity	Max. 100% RH
	Ambient temperature	-22...149°F [-30...65°C]
	Storage temperature	-40...176°F [-40...80°C]
	Servicing	maintenance-free
Weight	Weight	44 lb [20 kg]

Technical data

Materials	Housing material	die cast aluminium
	Gear train	high alloy steel gear sets, self locking





Product features

Application SY Series actuators are fractional horsepower devices, and utilize full-wave power supplies. Observe wire sizing and transformer sizing requirements. Proportional models CANNOT be connected to Belimo direct coupled (AF, AM, GM...etc) actuator power supplies or any type of half-wave device. You MUST use a separate, dedicated transformer or power supply to power the SY actuator. Please do not connect other automation equipment to the dedicated SY supply source. You MUST use four wires (plus a ground) to control a proportional control SY actuator (See SY Wiring Section).

Accessories

Gateways	Description	Type
	Gateway MP to BACnet MS/TP	UK24BAC
	Gateway MP to Modbus RTU	UK24MOD
	Gateway MP to LonWorks	UK24LON
Electrical accessories	Description	Type
	Local electric disconnect for SY4...12 series actuator, AC 120 V, MFT	HOA-120VMFT
	Service tool, with ZIP-USB function, for programmable and communicative Belimo actuators, VAV controller and HVAC performance devices	ZTH US
	Battery backup system for SY4...6 series actuator, AC 120 V, on/off	EXT-NSV-B03-120
	Battery backup system for SY4...6 series actuator, AC 120 V, MFT	EXT-NSV-B04-120
	Battery backup system for SY4...5 series actuator, AC 24 V, on/off	EXT-NSV-B13-24
	Battery backup system for SY4...5 series actuator, AC 24 V, MFT	EXT-NSV-B14-24
Tools	Description	Type
	Connecting cable 10 ft [3 m], A: RJ11 6/4 ZTH EU, B: 3-pin Weidmüller and supply connection	ZK4-GEN
	Service tool, with ZIP-USB function, for programmable and communicative Belimo actuators, VAV controller and HVAC performance devices	ZTH US

Electrical installation
 **INSTALLATION NOTES**

-  Do not change sensitivity or dip switch setting with power applied.
-  Power supply Common/Neutral and Control Signal "-" wiring to a common is prohibited. Terminals 4 and 6 need to be wired separately.
-  Isolation relays must be used in parallel connection of multiple actuators using a common control signal inputs. The relays should be DPDT.
-  Isolation relays are required in parallel applications. The reason parallel applications need isolation relays is that the motor uses two sets of windings, one for each direction. When one is energized to turn the actuator in a specific direction a voltage is generated in the other due to the magnetic field created from the first. It's called back EMF. This is not an issue with one actuator because the voltage generated in the second winding isn't connected to anything so there is no flow. On parallel applications without isolation, this EMF voltage energizes the winding it is connected to on the other actuators in the system, the actuators are trying to turn in both directions at once. The EMF voltage is always less than the supply voltage due to the resistance of the windings, so while the actuator still turns in the commanded direction, the drag from the other reduces the torque output and causes overheating.

 **Warning! Live electrical components!**

Electrical installation

During installation, testing, servicing and troubleshooting of this product, it may be necessary to work with live electrical components. Have a qualified licensed electrician or other individual who has been properly trained in handling live electrical components perform these tasks. Failure to follow all electrical safety precautions when exposed to live electrical components could result in death or serious injury.

Wiring diagrams

