

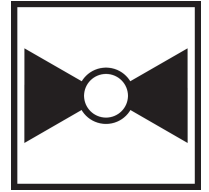

5-year warranty



Technical data

Functional data	Valve Size	6" [150]
	Fluid	chilled or hot water, up to 60% glycol
	Fluid Temp Range (water)	0...250°F [-18...120°C]
	Body Pressure Rating	ANSI Class 250, raised-face
	Close-off pressure Δps	310 psi
	Flow characteristic	equal percentage
	Servicing	maintenance-free
	Maximum differential pressure (water)	50 psi [345 kPa]
	Flow Pattern	2-way
	Leakage rate	0% for A – AB
	Controllable flow range	75°
	Cv	400
	Cv Flow Rating	A-port: as stated in chart B-port: 70% of A – AB Cv
	Materials	Valve body
Spindle		stainless steel
Spindle seal		EPDM (lubricated)
Seat		PTFE
Pipe connection		250 lb flanged
O-ring		EPDM (lubricated)
Ball		stainless steel
Suitable actuators	Non-Spring	GRB(X)
	Electrical fail-safe	GKRB(X)

Safety notes



- WARNING: This product can expose you to lead which is known to the State of California to cause cancer and reproductive harm. For more information go to www.p65warnings.ca.gov

Product features

Application This valve is typically used in air handling units on heating or cooling coils, and fan coil unit heating or cooling coils. Some other common applications include Unit Ventilators, VAV box re-heat coils and bypass loops. This valve is suitable for use in a hydronic system with variable flow.

Flow/Mounting details

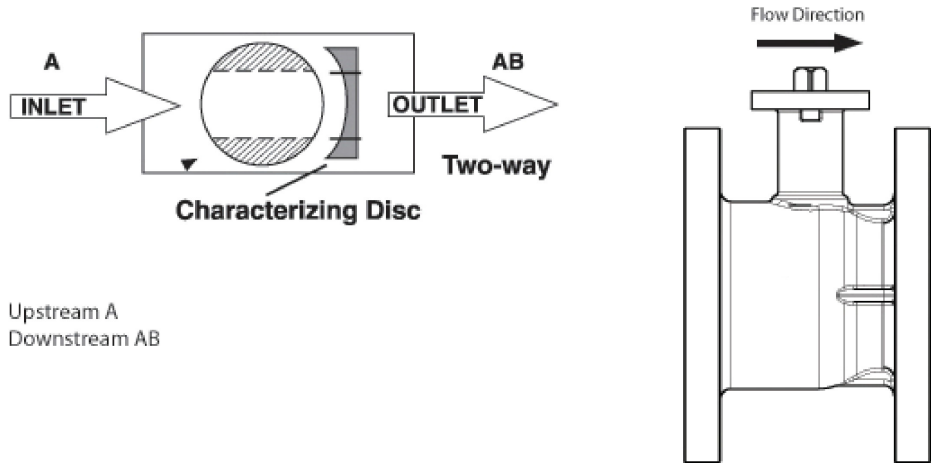

Dimensions

Dimensional drawings

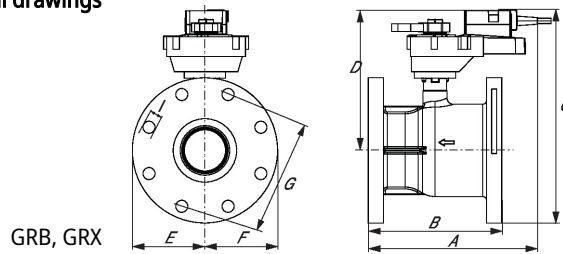

GRB, GRX

Type

DN

Weight [kg]
[kg]

B6600S-400-250

150

41

A	B	C	D	E	F	G	I	Number of Bolt Holes
15.3" [388]	12.4" [315]	15.4" [391]	9.5" [241]	6.3" [160]	6.3" [160]	10.6" [270]	0.9" [22]	12

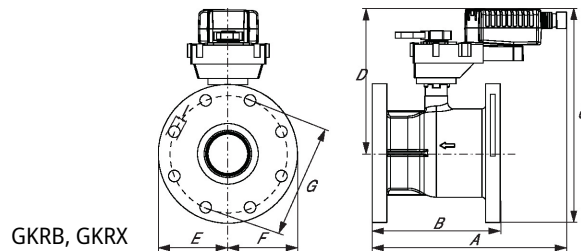

GKR, GKRX

A	B	C	D	E	F	G	I	Number of Bolt Holes
15.3" [388]	12.4" [315]	15.8" [401]	9.8" [248]	6.3" [160]	6.3" [160]	10.6" [270]	0.9" [22]	12

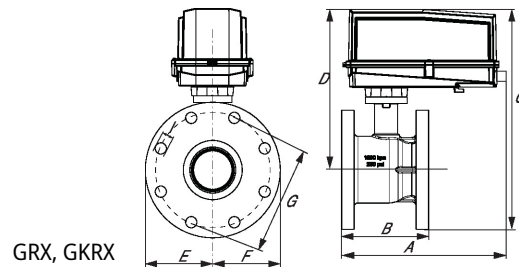

GRX, GKRX

A	B	C	D	E	F	G	I	Number of Bolt Holes
19.0" [483]	12.4" [315]	18.5" [470]	9.5" [241]	6.3" [160]	6.3" [160]	10.6" [270]	0.9" [22]	12

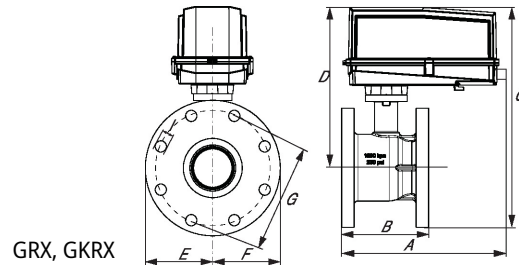

GRX, GKRX

A	B	C	D	E	F	G	I	Number of Bolt Holes
19.0" [483]	12.4" [315]	18.5" [470]	9.5" [241]	6.3" [160]	6.3" [160]	10.6" [270]	0.9" [22]	12

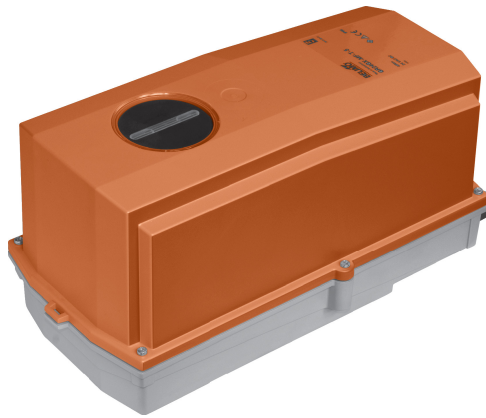

5-year warranty



Technical data

Electrical data	Nominal voltage	AC/DC 24 V
	Nominal voltage frequency	50/60 Hz
	Power consumption in operation	4 W
	Power consumption in rest position	2 W
	Transformer sizing	11 VA (class 2 power source)
	Electrical Connection	Terminal blocks
	Overload Protection	electronic throughout 0...95° rotation
Functional data	Direction of motion motor	selectable with switch 0/1
	Manual override	under cover
	Angle of rotation	90°
	Angle of rotation note	adjustable with mechanical stop
	Running Time (Motor)	150 s / 90°
	Running time motor note	constant, independent of load
	Noise level, motor	45 dB(A)
	Position indication	Mechanically, 30...65 mm stroke
Safety data	Degree of protection IEC/EN	IP66/67
	Degree of protection NEMA/UL	NEMA 4X
	Enclosure	UL Enclosure Type 4X
	Agency Listing	cULus acc. to UL60730-1A/-2-14, CAN/CSA E60730-1:02, CE acc. to 2014/30/EU and 2014/35/EU
	Quality Standard	ISO 9001
	Ambient temperature	-22...122°F [-30...50°C]
	Ambient temperature note	-40...50°C for actuator with integrated heating
	Storage temperature	-40...176°F [-40...80°C]
	Ambient humidity	Max. 100% RH
	Servicing	maintenance-free
Materials	Housing material	Die cast aluminium and plastic casing

Footnotes †Rated Impulse Voltage 800V, Type of action 1.AA, Control Pollution Degree 3

Accessories

Electrical accessories	Description	Type
	Battery backup system, for non-spring return models	NSV24 US
	Battery, 12 V, 1.2 Ah (two required)	NSV-BAT
	Auxiliary switch 1 x SPDT add-on	S1A
	Auxiliary switch 2 x SPDT add-on	S2A
	Feedback potentiometer 140 Ω add-on, grey	P140A GR
	Feedback potentiometer 1 kΩ add-on, grey	P1000A GR
	Feedback potentiometer 10 kΩ add-on, grey	P10000A GR
	Feedback potentiometer 2.8 kΩ add-on, grey	P2800A GR
	Feedback potentiometer 500 Ω add-on, grey	P500A GR
	Feedback potentiometer 5 kΩ add-on, grey	P5000A GR

Electrical installation

✂ INSTALLATION NOTES

- ⚠ Provide overload protection and disconnect as required.
- ⚠ Actuators may be connected in parallel. Power consumption and input impedance must be observed.
- ⚠ Actuators may also be powered by DC 24 V.
- ⚠ Actuators Hot wire must be connected to the control board common. Only connect common to neg. (-) leg of control circuits. Terminal models (-T) have no-feedback.
- ⚠ Actuators are provided with a numbered screw terminal strip instead of a cable.
- ◆ Meets cULus requirements without the need of an electrical ground connection.
- ⚠ **Warning! Live electrical components!**
During installation, testing, servicing and troubleshooting of this product, it may be necessary to work with live electrical components. Have a qualified licensed electrician or other individual who has been properly trained in handling live electrical components perform these tasks. Failure to follow all electrical safety precautions when exposed to live electrical components could result in death or serious injury.

Wiring diagrams

On/Off

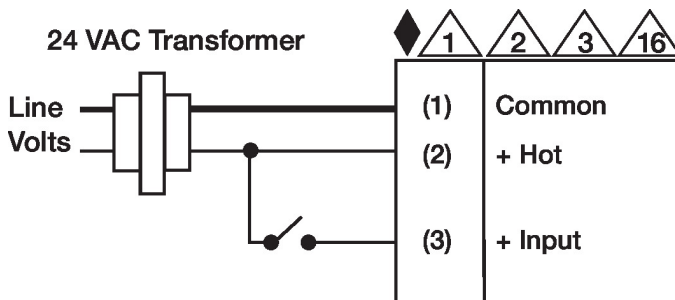

Floating Point

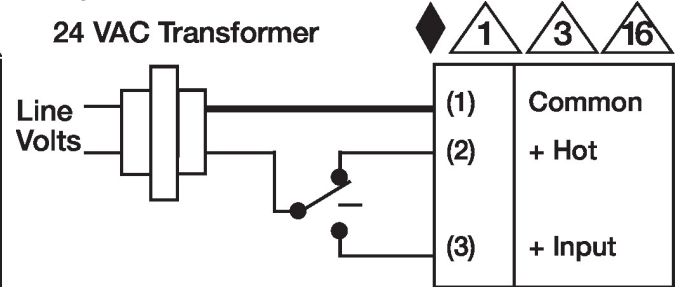

Floating Point - Triac Source
24 VAC Transformer

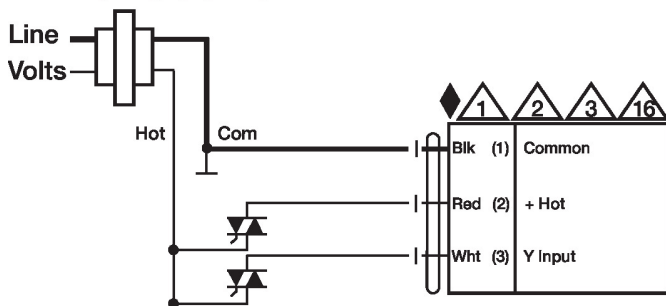

Floating Point - Triac Sink
24 VAC Transformer

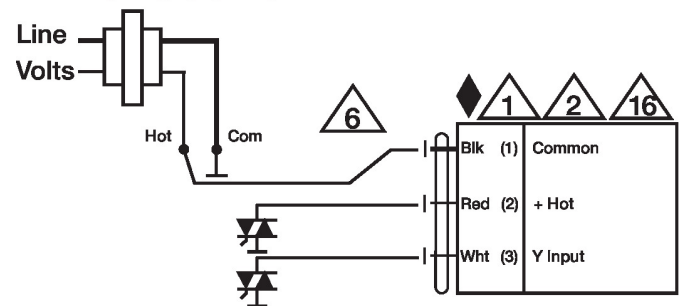

Dimensions