

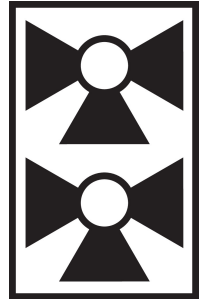

5-year warranty



Type overview

Type	DN
B320-290-290	20

Technical data

Functional data	Valve size [mm]	0.75" [20]
	Fluid	chilled or hot water, up to 60% glycol
	Fluid Temp Range (water)	43...180°F [6...82°C]
	Body Pressure Rating	232 psi
	Close-off pressure Δp_s	50 psi
	Differential pressure Δp_{max}	15psi
	Flow characteristic	linear
	Servicing	maintenance-free
	Flow Pattern	6-way
	Leakage rate	0%
	Controllable flow range	sequence 1 (angle 0...30°), dead zone (30...60°), sequence 2 (angle 60...90°)
	Seq 1 Cv	2.9
	Seq 2 Cv	2.9
	Materials	Valve body
Stem		nickel-plated brass
Stem seal		EPDM (lubricated)
Seat		PTFE
Characterized disc		chrome plated steel
Pipe connection		NPT
O-ring		EPDM
Ball	chrome plated brass	

Product features

Application The 6-way characterized control valve is ideal for chilled beams, radiant ceilings, and fan coil units offering reduced wiring by using a single actuator instead of two. It eliminates the need for a change-over valve and enables the use of a single coil for heating and cooling.

Operation A loop pressure relief is designed into port number two (2). This allows the increased pressure to dissipate to the supply loop on port number one (1). This is intended to release any pressure build up in the loop (coil) when the valve is in the closed position and is isolated from the system expansion vessel. The change in pressure occurs due to a change in the media temperature in the coil while isolated from the pressure vessel. The pressure relief does not affect the efficiency of the system because cross-flow cannot occur between the heating and cooling loops. The system loops (heating/cooling) should share a common expansion vessel to keep the system pressure and volume balanced.

Flow/Mounting details

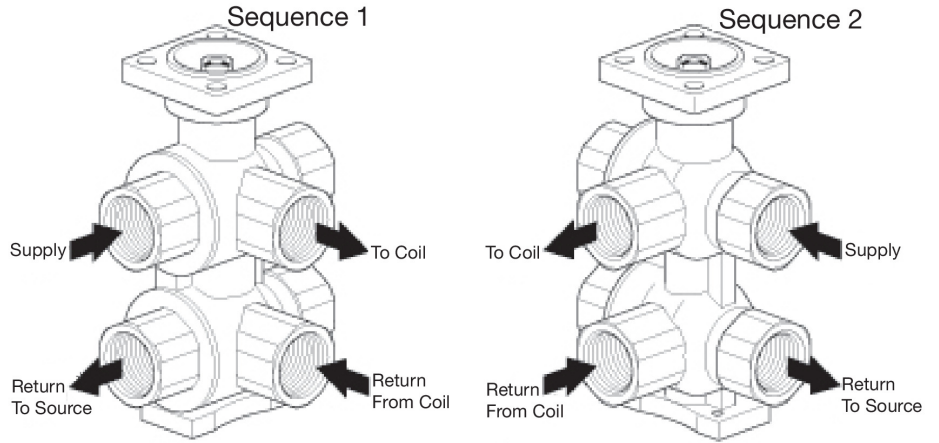

Accessories

Mechanical accessories	Description	Type
	Fixing bracket for 6-way valve DN 15/20	ZR-004

Dimensions

Type	DN	Weight
B320-290-290	20	4.63 lb [2.1 kg]

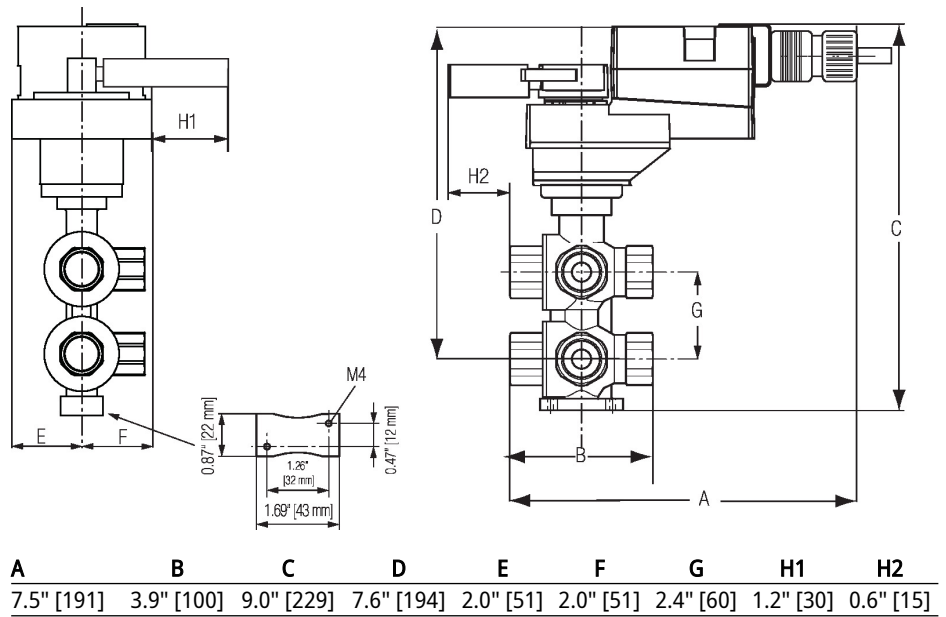



5-year warranty



Technical data

Electrical data	Nominal voltage	AC/DC 24 V
	Nominal voltage frequency	50/60 Hz
	Nominal voltage range	AC 19.2...28.8 V / DC 21.6...28.8 V
	Power consumption in operation	2.5 W
	Power consumption in rest position	1.2 W
	Transformer sizing	5 VA
	Electrical Connection	18 GA plenum cable with 1/2" conduit connector, degree of protection NEMA 2 / IP54, 1 m 3 m and 5 m
	Overload Protection	electronic throughout 0...90° rotation
	Electrical Protection	actuators are double insulated
Functional data	Operating range Y	2...10 V
	Operating range Y note	4...20 mA w/ ZG-R01 (500 Ω, 1/4 W resistor)
	Input Impedance	100 kΩ for DC 2...10 V (0.1 mA), 500 Ω for 4...20 mA, 1500 Ω for PWM and On/Off
	Operating range Y variable	Start point 0.5...30 V End point 2.5...32 V
	Operating modes optional	variable (VDC, on/off, floating point)
	Position feedback U	2...10 V
	Position feedback U note	Max. 0.5 mA
	Position feedback U variable	VDC variable
	Direction of motion motor	selectable with switch 0/1
	Manual override	external push button
	Angle of rotation	90°
	Angle of rotation note	adjustable with mechanical stop
	Running Time (Motor)	150 s / 90°
	Running time motor variable	35...150 s
	Noise level, motor	35 dB(A)
Position indication	Mechanically, pluggable	
Safety data	Power source UL	Class 2 Supply
	Degree of protection IEC/EN	IP54
	Degree of protection NEMA/UL	NEMA 2
	Enclosure	UL Enclosure Type 2
	Agency Listing	cULus acc. to UL60730-1A/-2-14, CAN/CSA E60730-1:02, CE acc. to 2014/30/EU
	Quality Standard	ISO 9001
	UL 2043 Compliant	Suitable for use in air plenums per Section 300.22(C) of the NEC and Section 602 of the IMC
	Ambient humidity	Max. 95% RH, non-condensing

Safety data	Ambient temperature	-22...122°F [-30...50°C]
	Storage temperature	-40...176°F [-40...80°C]
	Servicing	maintenance-free
Weight	Weight	1.5 lb [0.70 kg]
Materials	Housing material	Galvanized steel and plastic housing

Footnotes †Rated Impulse Voltage 800V, Type action 1.B, Control Pollution Degree 3.

Accessories

Gateways	Description	Type
	Gateway MP to BACnet MS/TP	UK24BAC
	Gateway MP to Modbus RTU	UK24MOD
	Gateway MP to LonWorks	UK24LON
Electrical accessories	Description	Type
	Battery backup system, for non-spring return models	NSV24 US
	Battery, 12 V, 1.2 Ah (two required)	NSV-BAT
	Auxiliary switch 1 x SPDT add-on	S1A
	Auxiliary switch 2 x SPDT add-on	S2A
	Feedback potentiometer 140 Ω add-on, grey	P140A GR
	Feedback potentiometer 1 kΩ add-on, grey	P1000A GR
	Feedback potentiometer 10 kΩ add-on, grey	P10000A GR
	Feedback potentiometer 2.8 kΩ add-on, grey	P2800A GR
	Feedback potentiometer 500 Ω add-on, grey	P500A GR
	Feedback potentiometer 5 kΩ add-on, grey	P5000A GR
Tools	Description	Type
	Connection cable 10 ft [3 m], A: RJ11 6/4 ZTH EU, B: 3-pin Weidmüller and supply connection	ZK4-GEN
	Service Tool, with ZIP-USB function, for programmable and communicative Belimo actuators, VAV controller and HVAC performance devices	ZTH US

Electrical installation
INSTALLATION NOTES

- Provide overload protection and disconnect as required.
- Actuators may be connected in parallel. Power consumption and input impedance must be observed.
- Actuators may also be powered by DC 24 V.
- Only connect common to negative (-) leg of control circuits.
- A 500 Ω resistor (ZG-R01) converts the 4...20 mA control signal to 2...10 V.
- Control signal may be pulsed from either the Hot (Source) or Common (Sink) 24 V line.
- For triac sink the Common connection from the actuator must be connected to the Hot connection of the controller. Position feedback cannot be used with a triac sink controller; the actuator internal common reference is not compatible.
- IN4004 or IN4007 diode. (IN4007 supplied, Belimo part number 40155).
- Actuators with plenum cable do not have numbers; use color codes instead.
- Meets cULus requirements without the need of an electrical ground connection.
- Warning! Live electrical components!**
During installation, testing, servicing and troubleshooting of this product, it may be necessary to work with live electrical components. Have a qualified licensed electrician or other individual who has been properly trained in handling live electrical components perform these tasks. Failure to follow all electrical safety precautions when exposed to live electrical components could result in death or serious injury.

Wiring diagrams

On/Off



Floating Point

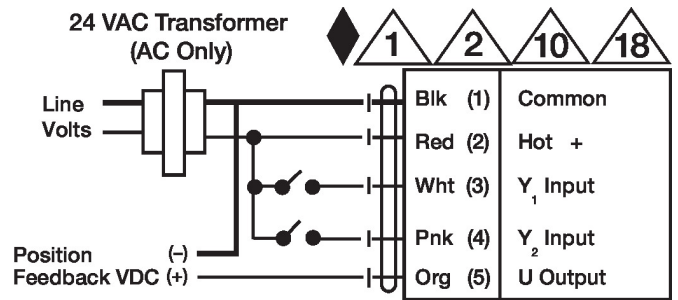

VDC/mA Control

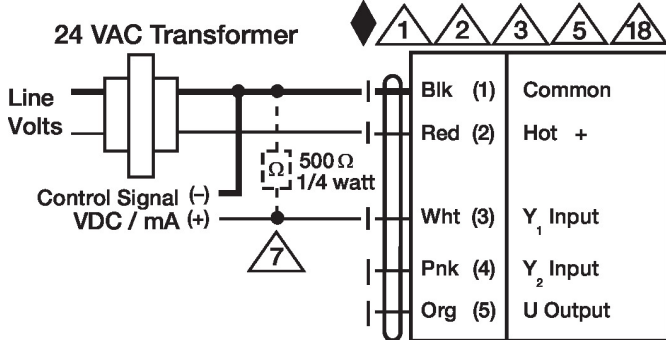

PWM Control

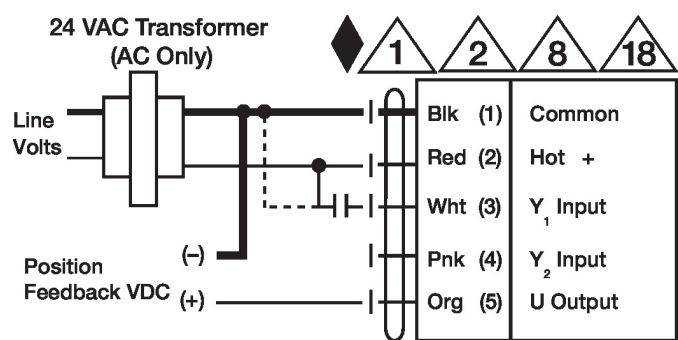

Override Control

